

367408 - 75. (3000)

L.50-LAKEN -TERNAT.

Nº 50-A1-0675.

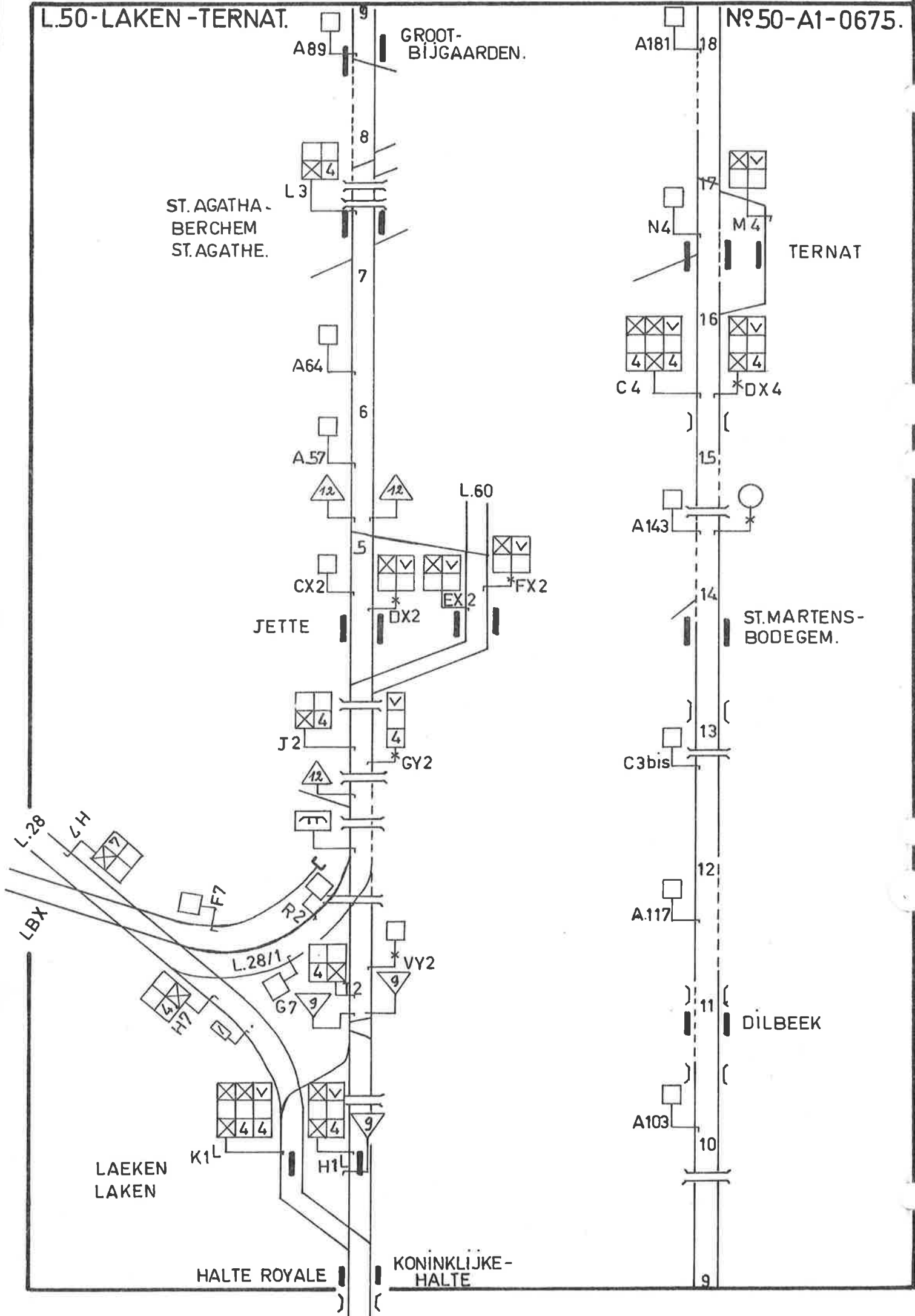

GROOT-BIJGAARDEN.

ST. AGATHA -
BERCHEM
ST. AGATHE.

JETTE

LAEKEN
LAKEN

HALTE ROYALE

KONINKLIJKE-
HALTE

TERNAT

ST. MARTENS-
BODEGEM.

DILBEEK

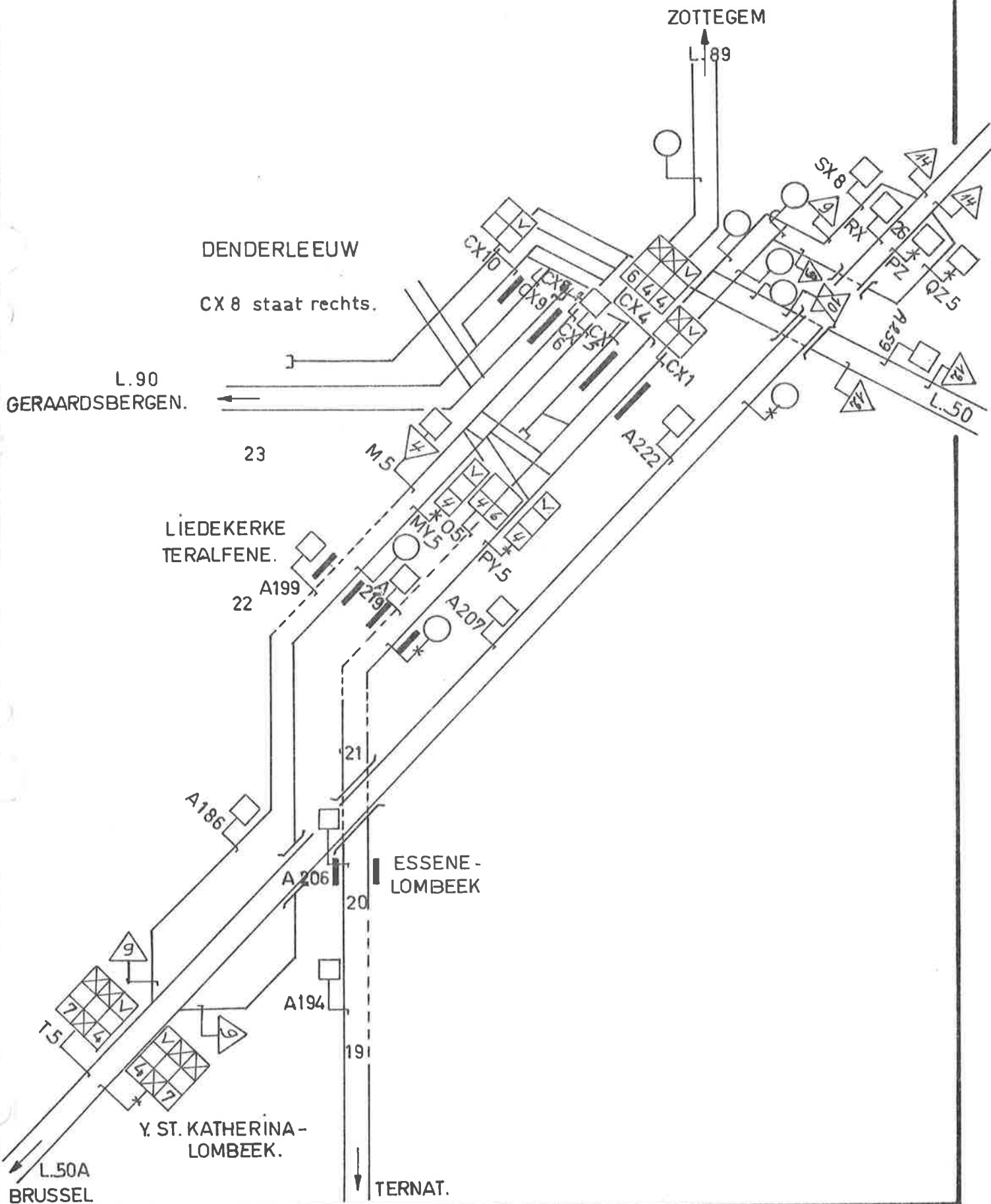

367408.775 (3000)

L.50 - DENDERLEEUV - LEDE.
L.82 - AALST - BURST.

Nº 50 - A2 - 0675.

LEDE.

(Lijn
Ligne 82)

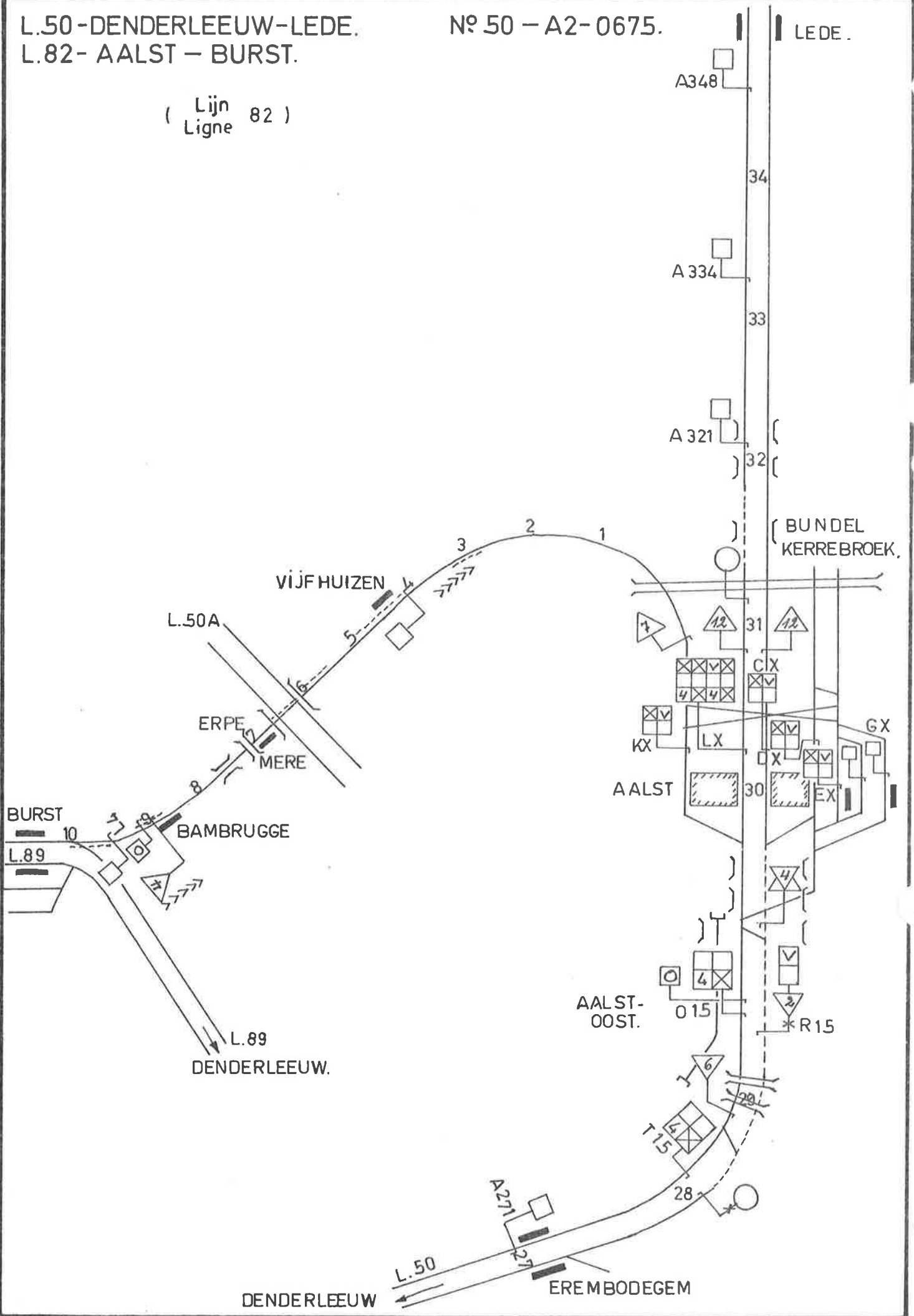

L.50-LEDE - Y. OOST EST Δ LEDEBERG. № 50-A3-0675.

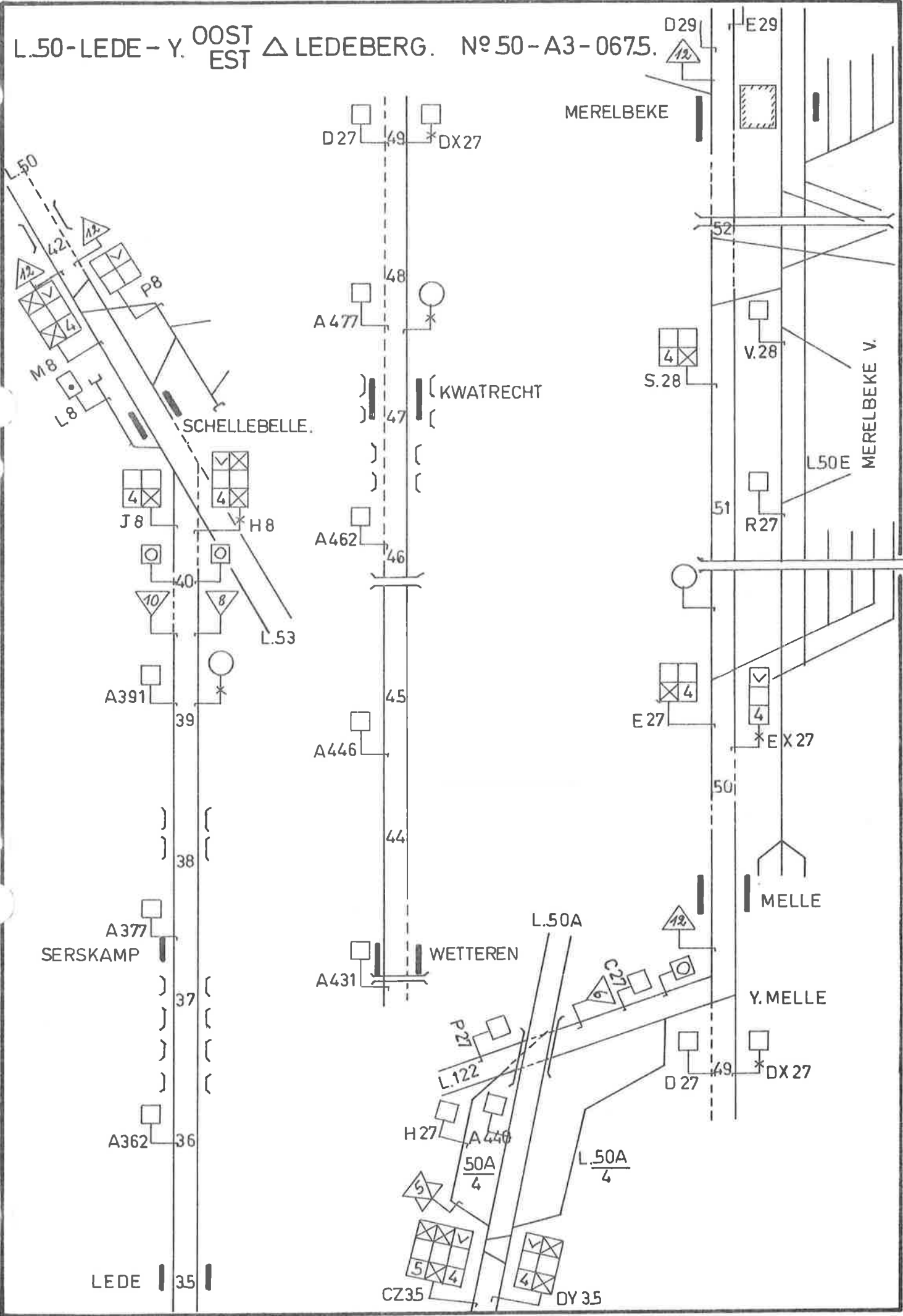

367.408. (5 (3000))

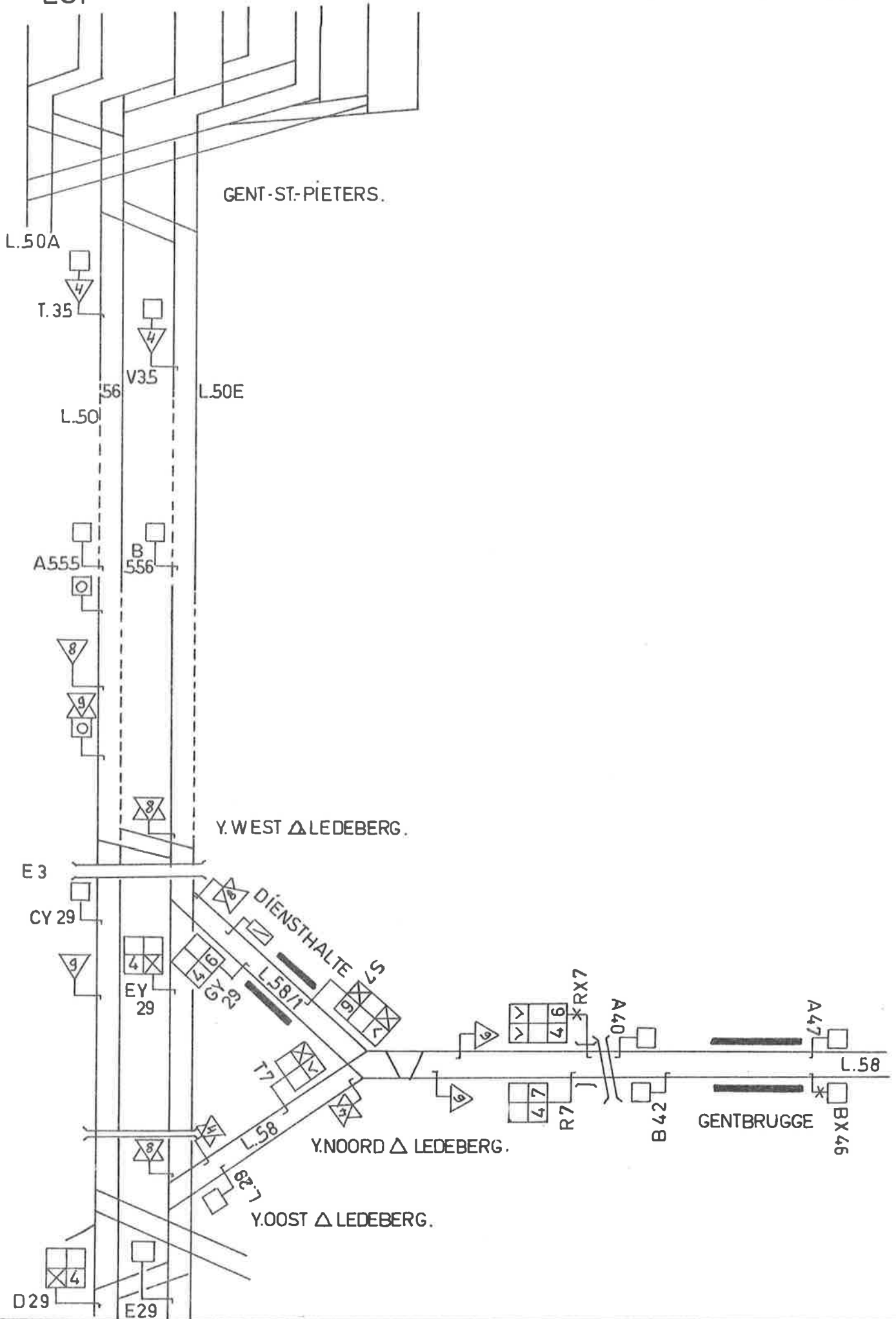

L.50-GENT-ST-PIETERS-Y.^{OOST} EST Δ LEDEBERG.

Nº 50 - B1 - 0675.

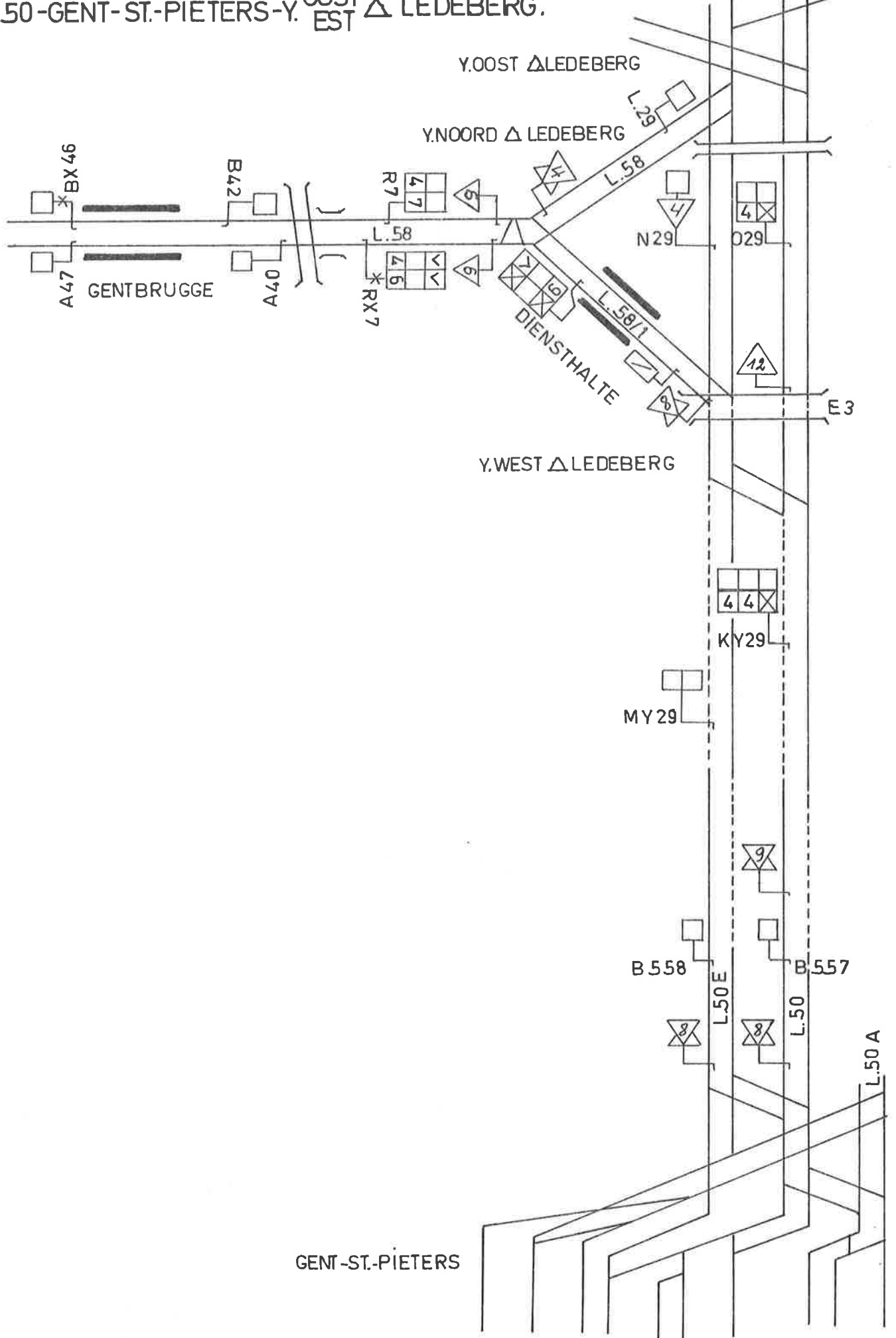

367408.7.75 (3000)

L.50-Y. OOST- Δ
EST- Δ
LEDEBERG-LEDE

Nº 50 - B1 - 0675.

Y. MEULEWIJK

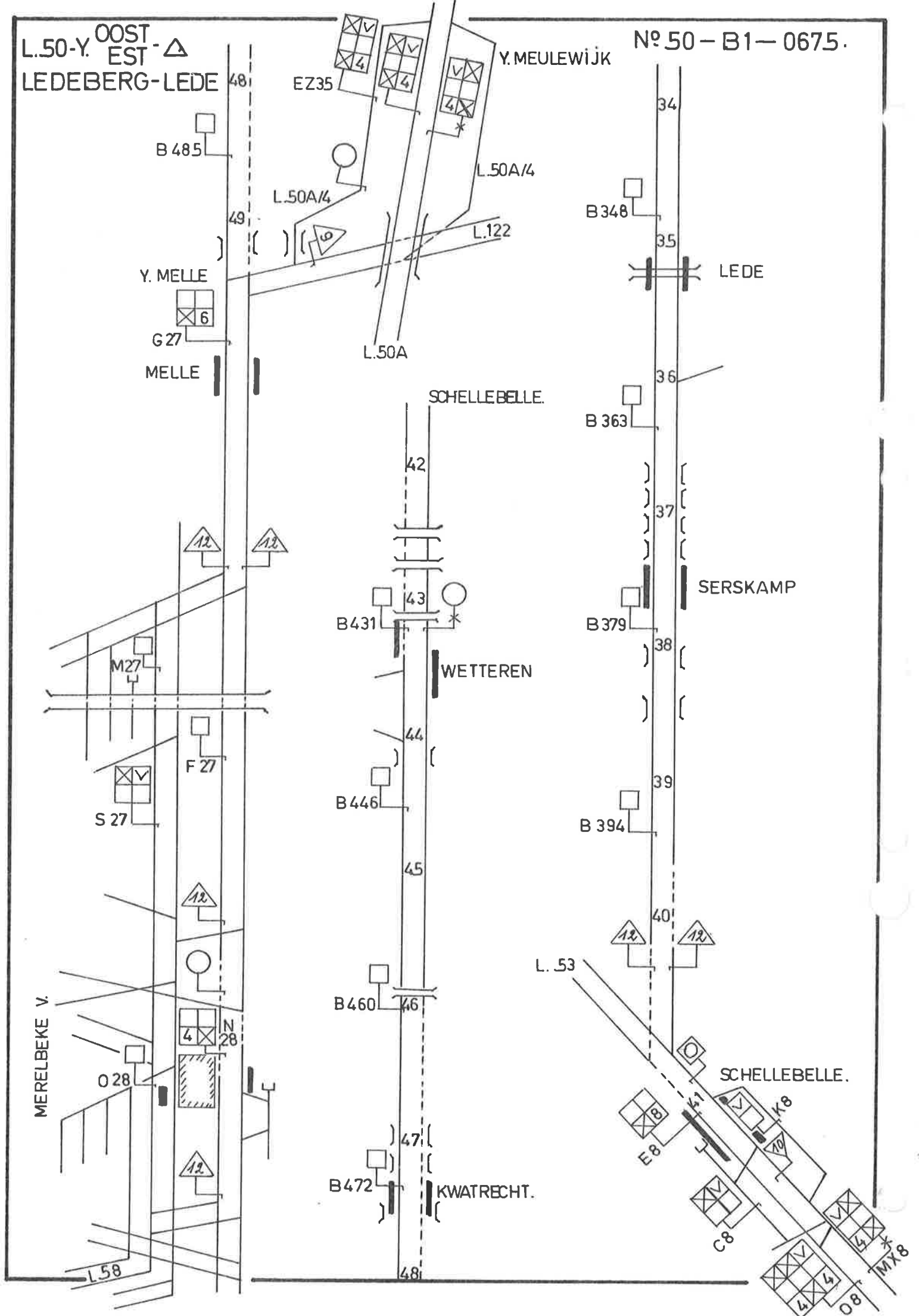

EZ35

L.50A/4

L.50A/4

L.122

L.50A

SCHELLEBELLE.

LEDE

SERSKAMP

WETTEREN

SCHELLEBELLE.

KWATRECHT.

MERELBEKE V.

L. 53

L.58

MX8

Nº 50 - B2 - 0675.

L. 50 - EREMBODEGEM - TERNAT.

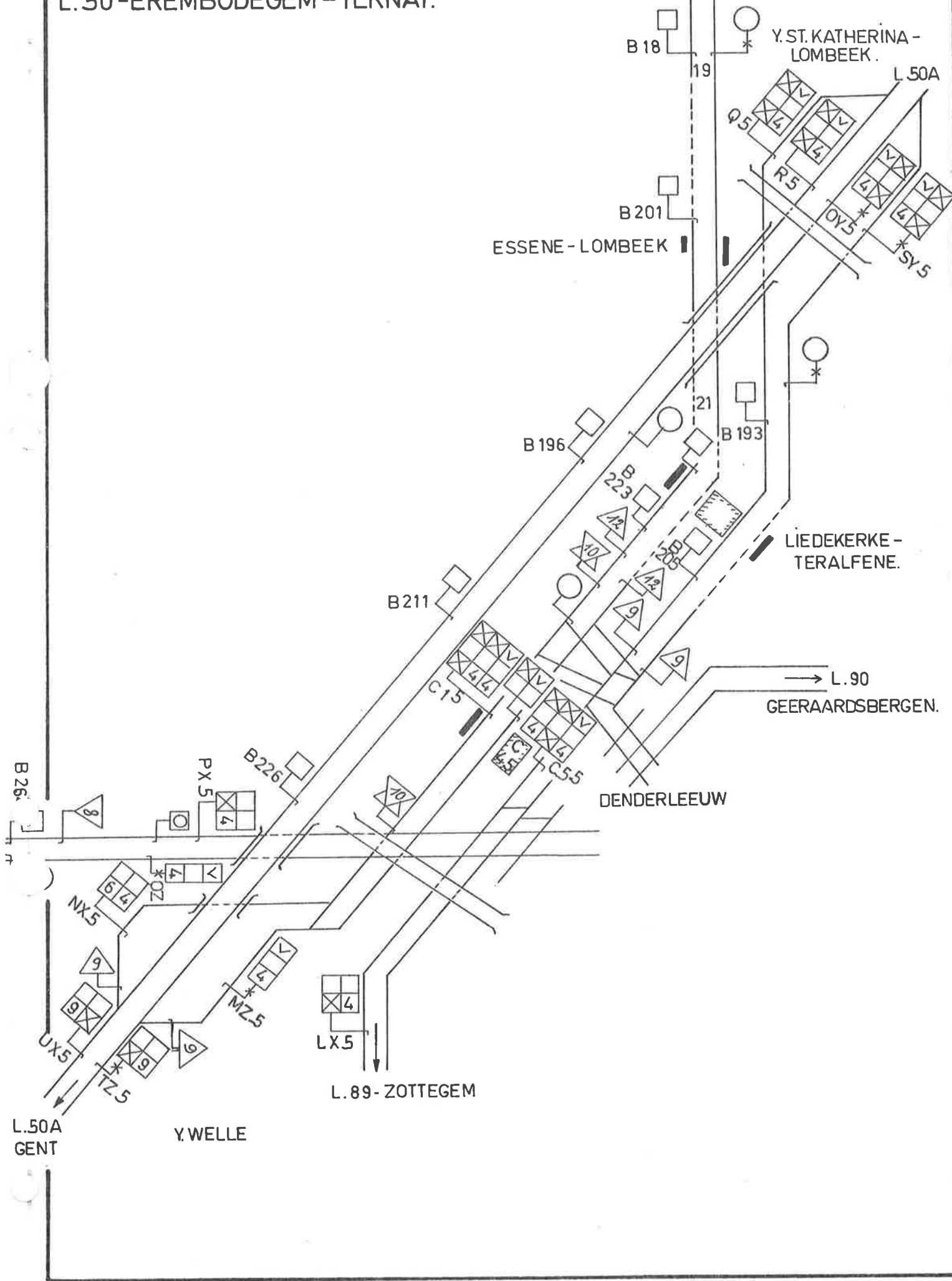

L.50-LEDE-EREMBODEGEM.
L.82- BURST - AALST.

EREMBODEGEM

(Lijn
Ligne 82)

Nº 50 - B2 - 0675,

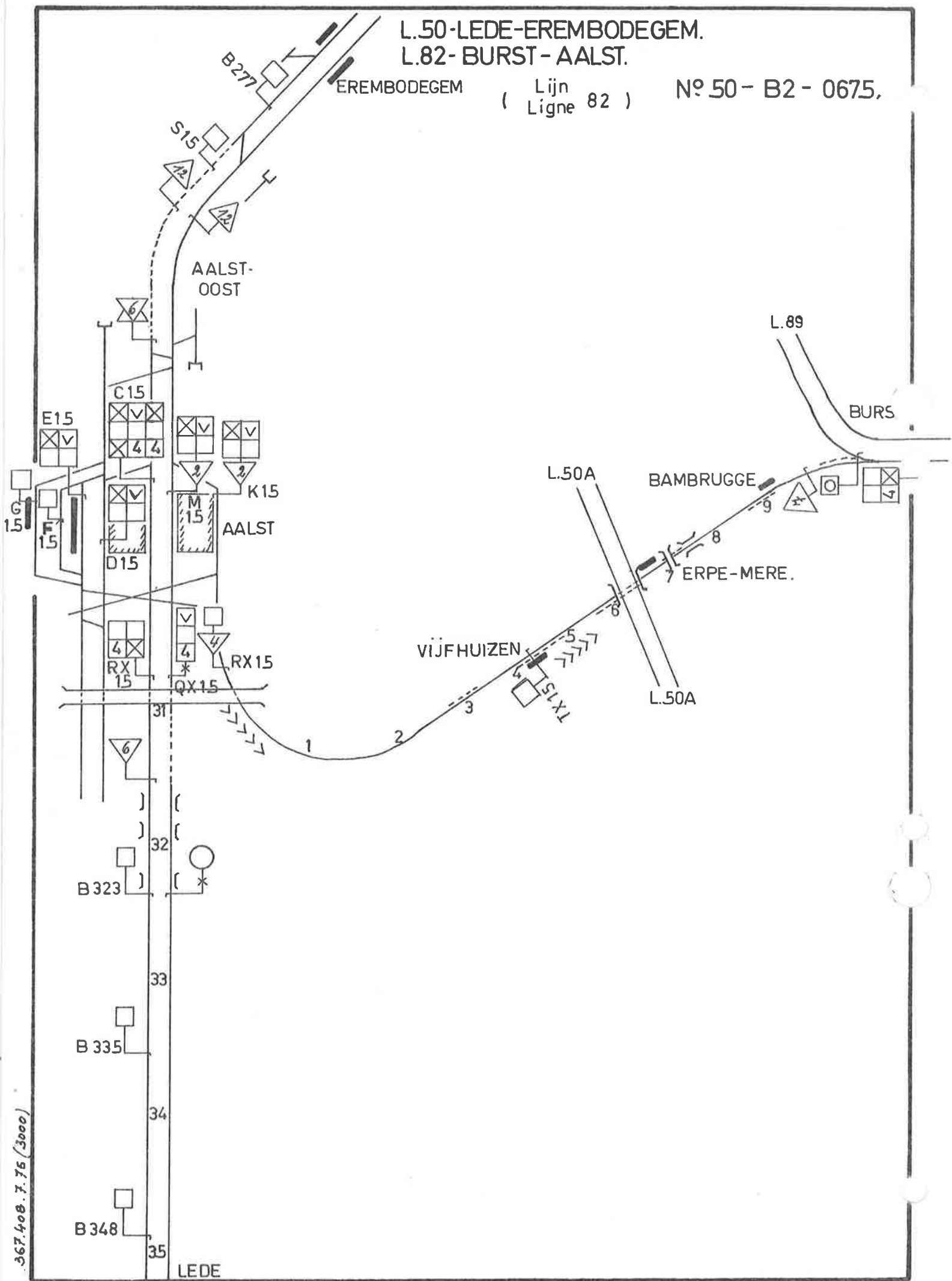

367.408.7.76 (3000)

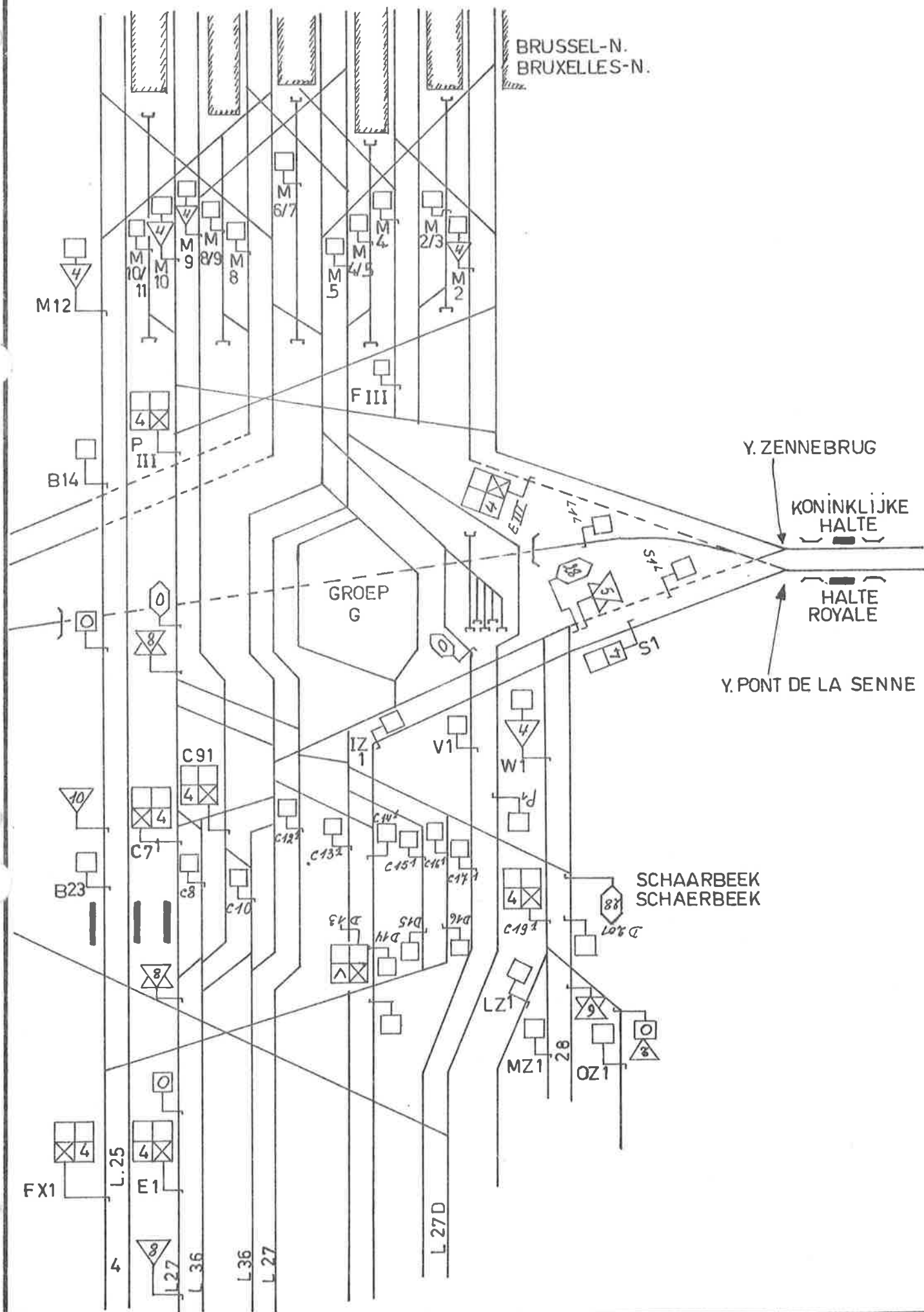

L.50-TERNAT-LAKEN.

KONINKLIJKE HALTE N° 50 - B3 - 0675
HALTE ROYALE

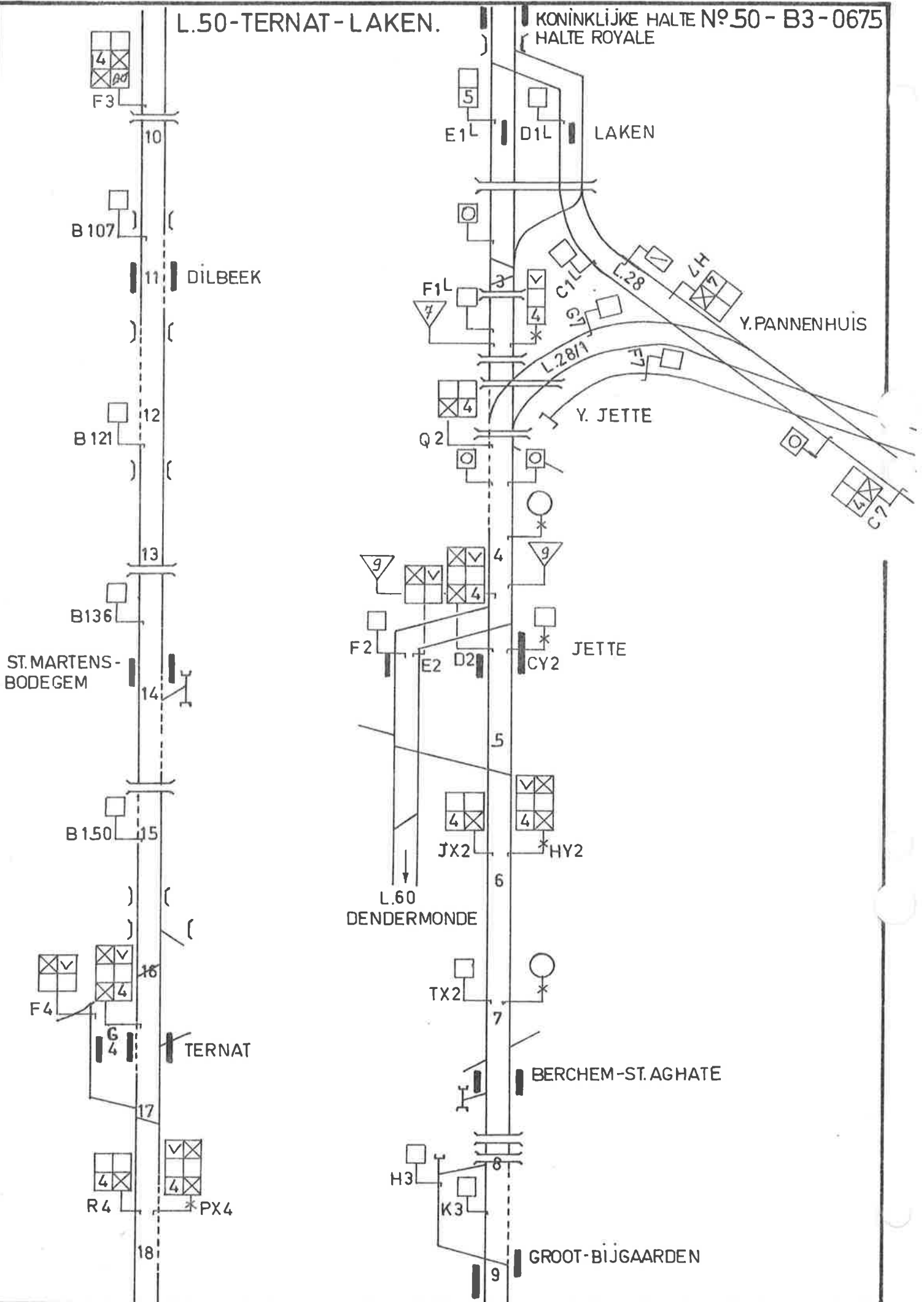

367.408.7.75 (1000)